

	TMIP E30-40	TMIP E45-60
$d_{min} - d_{max}$ mm in	30 - 40 1.2 - 1.6	45 - 60 1.8 - 2.4
	6006 - 6408 16006 - 16008	6009 - 6412 16009 - 16012
	1206 - 2308	1209 - 1412
	3206 - 5408	3209 - 5412
	4206 - 4308	4209 - 4312

TMIP 30-60
MP 5338

TMBA G11W

1 ?

	TMIP E30-40	TMIP E45-60
$d_{min} - d_{max}$ mm in	30 - 40 1.2 - 1.6	45 - 60 1.8 - 2.4
	6006 - 6408 16006 - 16008	6009 - 6412 16009 - 16012
	1206 - 2308	1209 - 1412
	3206 - 5408	3209 - 5412
	4206 - 4308	4209 - 4312

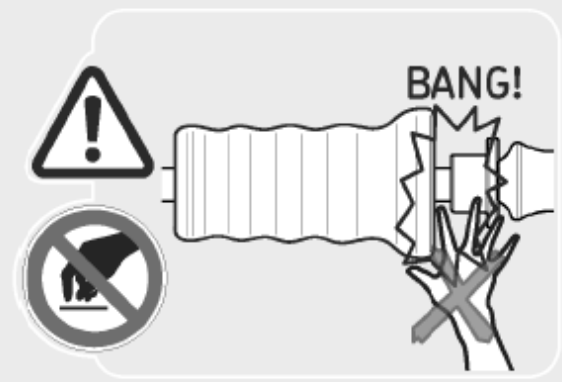
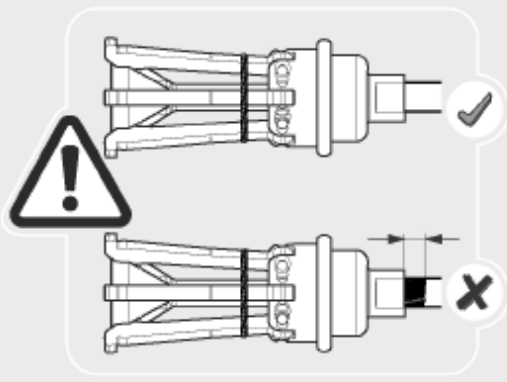
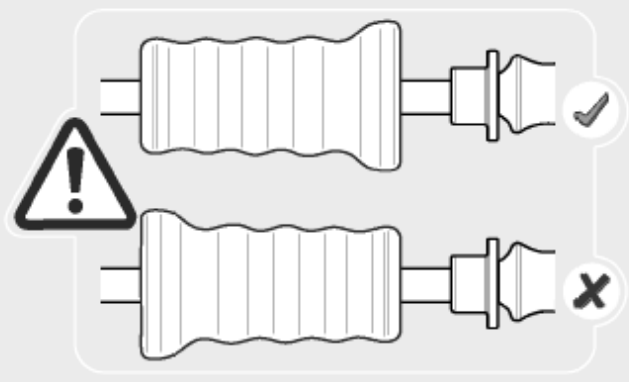
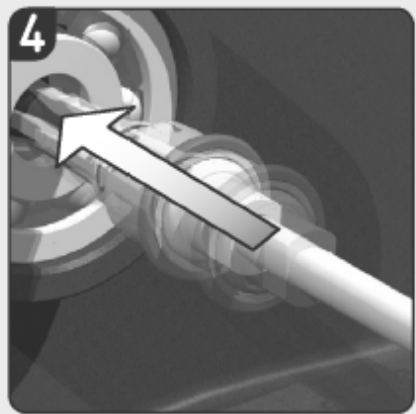
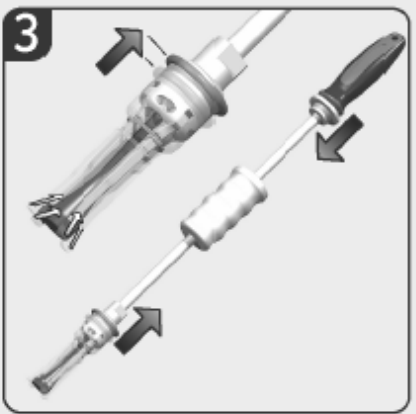
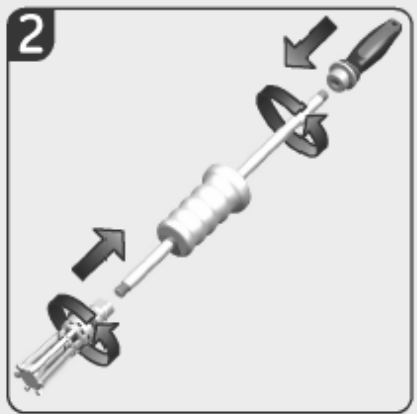

Termékeink folyamatos fejlesztésére törekedve fenntartjuk magunknak a jogot a fenti műszaki leírás bármely részének előzetes bejelentés nélküli megváltoztatására. Bár mindent megtettünk a jelen kiadvány pontosságának biztosításáért, az esetleges hibákért és kihagyásokért az SKF semmilyen felelősséget nem vállal.

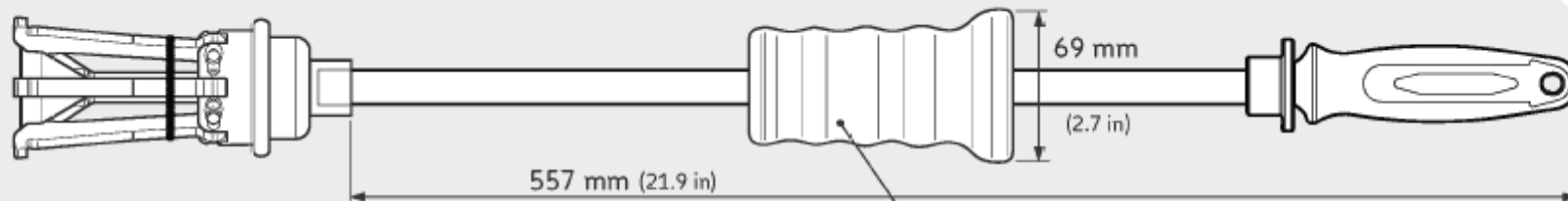

	A_{max} mm in	L_{max} mm in	H mm in	G mm in
 TMIP E30-40	11.5 0.45	97 3.8	>35 >1.4	143 5.6
 TMIP E45-60	15 0.6	102 4.0	>64 >2.5	152 6.0

